

# INTERMITTORE-OSCILLATORE INTERMITTENT-OSCILLATING DRIVE AP-OP 70

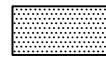

ROTANTE  
ROTATING

PESO / Weight

Kg. 8,0

DISPONIBILE SU DISCO CAD  
Available on CAD disc

FILE  
W40646

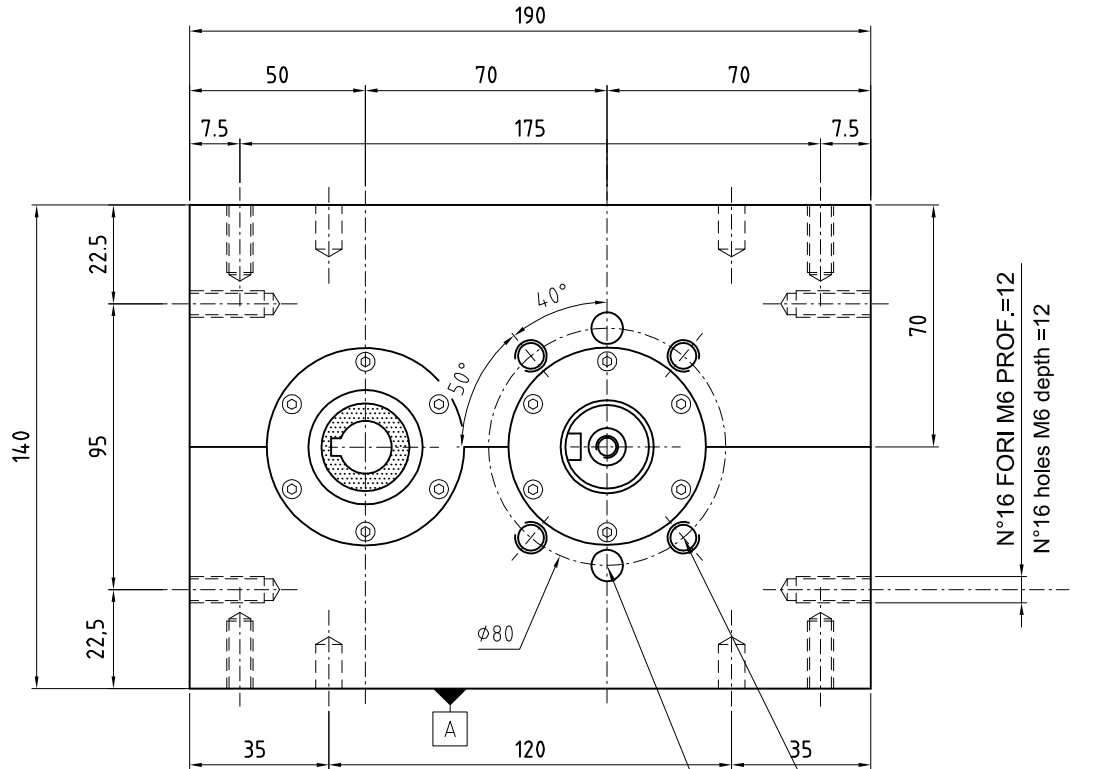

N°16 FORI M6 PROF.=12  
N°16 holes M6 depth =12

N°4 FORI Ø 8H7 PROF.=20 ANCHE SU PIANO A  
N°4 holes i.d. 8H7 depth = 20 on plane A too

N°4 FORI M8 PROF.=17  
N°4 holes M8 depth =17

N°2 FORI Ø8H7 PROF.=15  
N°2 holes i.d. 8H7 depth =15

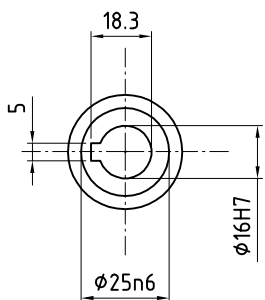
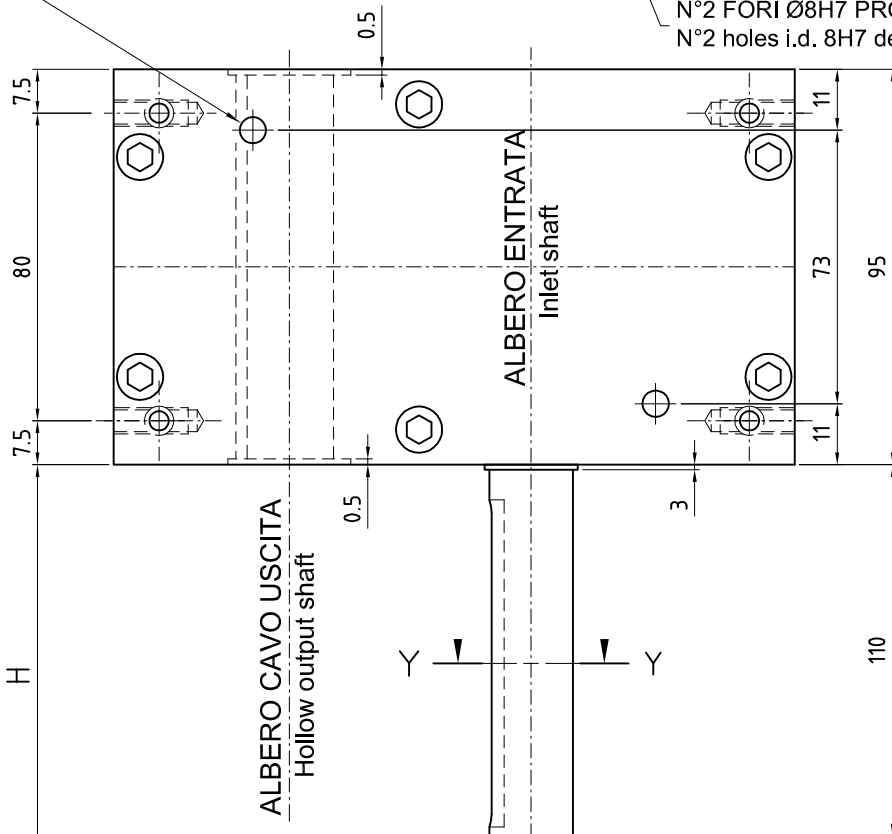

ALBERO CAVO USCITA  
Output shaft

DISTANZA ASSE UNITA' MOTRICE (VEDI CATALOGO)  
Power drive unit C.L. distance ( see catalog )

